

# Primjena površinskih integrala

Izračunavanje površine dijela glatke površi, koja pripada prostoru  $\mathbb{R}^3$

Neka je površ  $S$  zadana jednačinom  $z = z(x, y)$  gdje su  $(x, y) \in D$ , ( $D$  - je oblast u ravni  $xOy$  u koju se projektuje površ  $z = z(x, y)$ ).

Površina  $P$  dijela glatke površi  $S \subseteq \mathbb{R}^3$  računa se po formuli:

$$P = \iint_S dS = \iint_D \sqrt{1 + (z'_x)^2 + (z'_y)^2} dx dy.$$

# Izračunati površinu dijela lopte  $x^2 + y^2 + z^2 = 3a^2$  koja se nalazi ispod parabole  $x^2 + y^2 = 2az$  a iznad  $xOy$  ravnini.

Rj. Na osnovu skica presjeka datih površina sa  $xOz$  i  $yOz$  ravninama demo vidjeti kako tijela su u pitanju.

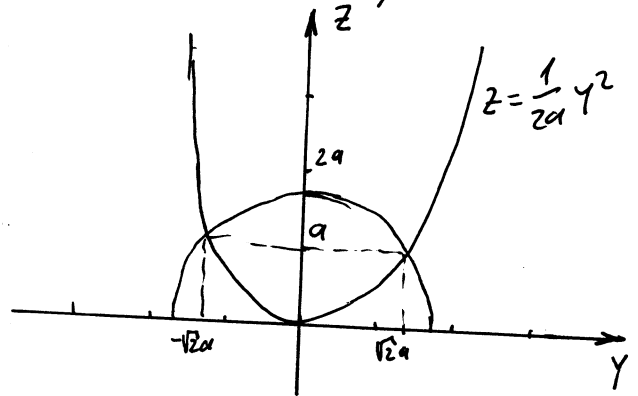
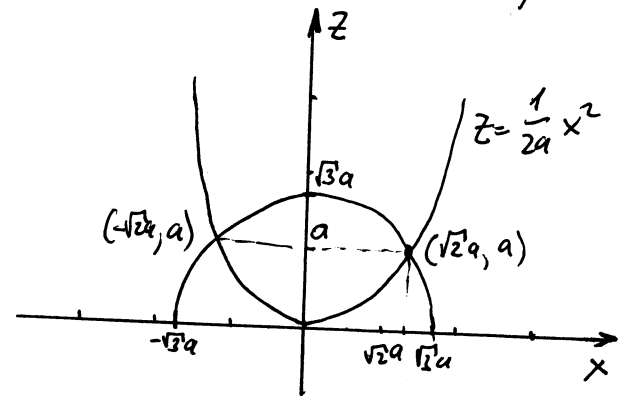

$$x^2 + z^2 = 3a^2$$

$$x^2 = 2az$$

$$z^2 + 2az - 3a^2 = 0$$

$$D = 4a^2 + 12a^2 = 16a^2$$

$$z_{1,2} = \frac{-2a \pm 4a}{2}$$

$$z_1 = a \quad z_2 = -3a$$

$$P = \iint_S dS$$

površinski integral prve vrste

$$z^2 = 3a^2 - x^2 - y^2$$

$$z = \pm \sqrt{3a^2 - x^2 - y^2}$$

U našem slučaju  $S$  je  $z = \sqrt{3a^2 - x^2 - y^2}$  i to do ove površine koji se nalazi ispod parabole

$$P = \iint_S dS = \iint_D \sqrt{1 + (z'_x)^2 + (z'_y)^2} dx dy$$

$$z'_x = \frac{-2x}{2\sqrt{3a^2 - x^2 - y^2}}, \quad z'_y = \frac{-y}{\sqrt{3a^2 - x^2 - y^2}}$$

$$1 + (z'_x)^2 + (z'_y)^2 = 1 + \frac{x^2}{3a^2 - x^2 - y^2} + \frac{y^2}{3a^2 - x^2 - y^2} = \frac{3a^2}{3a^2 - x^2 - y^2}$$

$$P = \sqrt{3}a \iint_D \frac{dx dy}{\sqrt{3a^2 - x^2 - y^2}}$$

gdje je  $D$  projekcija površine  $S$  na  $xOy$  ravan. U našem slučaju

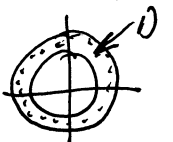

Uvedimo polarne koordinate

$$x = r \cos \varphi$$

$$y = r \sin \varphi$$

$$dx dy = r dr d\varphi$$

$$D \xrightarrow{\text{transformacija}} D' = \begin{cases} \sqrt{2}a \leq r \leq \sqrt{3}a \\ 0 \leq \varphi \leq 2\pi \end{cases}$$

$$x^2 + y^2 = r^2$$

$$\rho = \sqrt{3}a \iint_{D'} \frac{r dr d\varphi}{\sqrt{3a^2 - r^2}} = \sqrt{3}a \int_0^{2\pi} d\varphi \int_{\sqrt{2}a}^{\sqrt{3}a} \frac{r dr}{\sqrt{3a^2 - r^2}} = \left| \begin{array}{l} 3a^2 - r^2 = t^2 \\ -2r dr = 2t dt \\ r \Big|_{\sqrt{2}a}^{\sqrt{3}a} \Rightarrow t \Big|_a^0 \end{array} \right|$$

$$= \sqrt{3}a \int_0^{2\pi} d\varphi \int_0^a \frac{t dt}{t} = 2a^2 \sqrt{3} \pi$$

traženo  
rešenje

# Izračunati površinu onog dijela kupe  $z^2 = x^2 + y^2$  koji se nalazi unutar valjka  $x^2 + y^2 = 2x$ .

Rj.

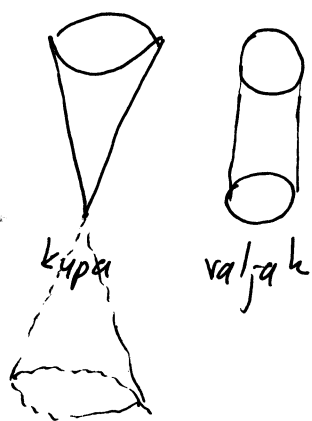

Prema zadatku dio kupe se nalazi unutar valjka

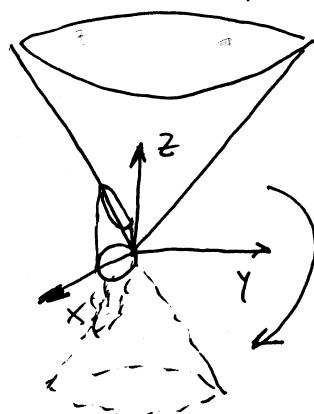

$$x^2 + y^2 = 2x$$

$$x^2 - 2x + 1 + y^2 = 1$$

$$(x-1)^2 + y^2 = 1$$

sličnu figuru ćemo imati i sa druge strane  $xOy$  ravni.

$P = \iint_S ds$  gdje je  $S$  dio kupe koji se nalazi unutar valjka

$$P = \iint_D \sqrt{1 + z_x'^2 + z_y'^2} dx dy$$

$$z = \pm \sqrt{x^2 + y^2}$$

Ako za  $z$  uzmemo  $z = \sqrt{x^2 + y^2}$  dobićemo površinu dijela kupe iznad  $xOy$  ravni.

$$z = \sqrt{x^2 + y^2}$$

$$z'_x = \frac{x}{\sqrt{x^2 + y^2}}, \quad z'_y = \frac{y}{\sqrt{x^2 + y^2}}, \quad 1 + z_x'^2 + z_y'^2 = 1 + \frac{x^2}{x^2 + y^2} + \frac{y^2}{x^2 + y^2} = 1 + 1 = 2$$

$D$ : unutrašnjost kruga  $x^2 + y^2 = 2x$

uvodimo polarne koordinate

$$x = r \cos \varphi + 1$$

$$y = r \sin \varphi$$

$$dx dy = r dr d\varphi$$

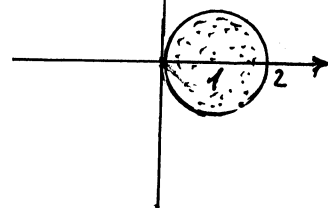

$$D \xrightarrow{\text{transf.}} D' : \begin{cases} 0 \leq r \leq 1 \\ 0 \leq \varphi \leq 2\pi \end{cases}$$

$$\frac{1}{2} P = \iint_D \sqrt{2} dx dy = \sqrt{2} \iint_{D'} r dr d\varphi = \sqrt{2} \int_0^{2\pi} d\varphi \int_0^1 r dr = \sqrt{2} \cdot \frac{1}{2} r^2 \Big|_0^1 \varphi \Big|_0^{2\pi} = \sqrt{2} \pi$$

$$P = 2\sqrt{2} \pi$$

(#) Izračunati površinu dijela površi  $S: z^2 = 2xy$  određene u prvom oktantu u presjeka sa ravninama:  $x=0, y=0$  i  $x+y=1$ .

Rj. Uputa:  $B(a, b) = \int_0^a x^{a-1} (1-x)^{b-1} dx$ ,  $B(\frac{3}{2}, \frac{3}{2}) = \frac{\pi}{8}$ ,  $B(\frac{1}{2}, \frac{5}{2}) = \frac{3\pi}{8}$ .

$$P = \iint_S dS = \iint_D \sqrt{1 + (z'_x)^2 + (z'_y)^2} dx dy$$

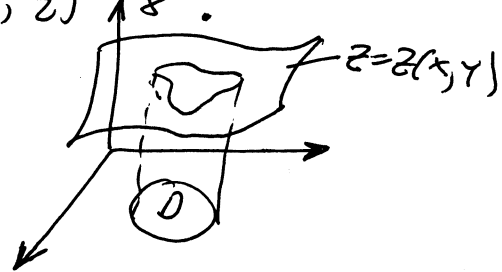

Kako je površina  $S$  u prvom oktantu, u našem slučaju je

$$S: z = \sqrt{2} \sqrt{xy}$$

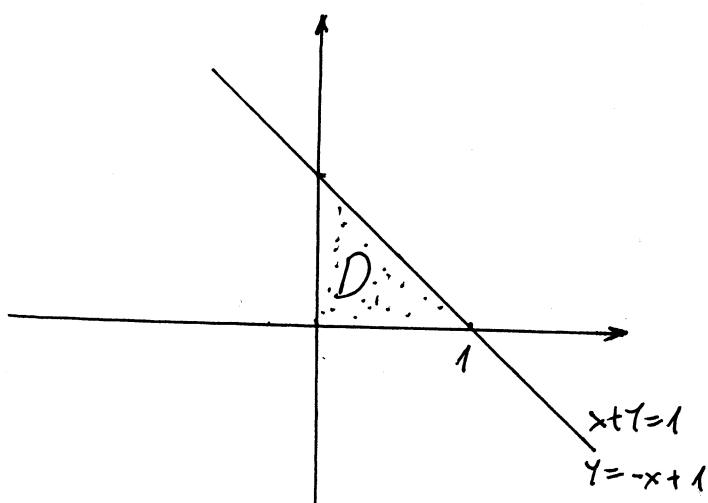

$$z'_x = \sqrt{2} \frac{y}{2\sqrt{xy}}$$

$$z'_y = \sqrt{2} \frac{x}{2\sqrt{xy}}$$

$$1 + (z'_x)^2 + (z'_y)^2 = 1 + \frac{y^2}{2xy} + \frac{x^2}{2xy} = \frac{2xy + y^2 + x^2}{2xy} = \frac{(x+y)^2}{2xy}$$

$$P = \iint_S dS = \iint_D \frac{x+y}{\sqrt{2xy}} dx dy = \frac{1}{\sqrt{2}} \int_0^1 dx \int_0^{-x+1} \frac{(x+y)}{\sqrt{xy}} dy =$$

$$= \frac{1}{\sqrt{2}} \int_0^1 dx \int_0^{1-x} (x \cdot x^{-\frac{1}{2}} \cdot y^{-\frac{1}{2}} + y \cdot x^{-\frac{1}{2}} \cdot y^{-\frac{1}{2}}) dy = \frac{1}{\sqrt{2}} \int_0^1 dx \int_0^{1-x} (x^{\frac{1}{2}} y^{-\frac{1}{2}} + x^{-\frac{1}{2}} y^{\frac{1}{2}}) dy$$

$$= \frac{1}{\sqrt{2}} \int_0^1 (x^{\frac{1}{2}} \frac{y^{\frac{1}{2}}}{\frac{1}{2}} \Big|_0^{1-x} + x^{-\frac{1}{2}} \frac{y^{\frac{3}{2}}}{\frac{3}{2}} \Big|_0^{1-x}) dx = \frac{2}{\sqrt{2}} \int_0^1 x^{\frac{1}{2}} (1-x)^{\frac{1}{2}} dx +$$

$$+ \frac{2}{3\sqrt{2}} \int_0^1 x^{-\frac{1}{2}} (1-x)^{\frac{3}{2}} dx = \sqrt{2} \int_0^1 x^{\frac{3}{2}-1} (1-x)^{\frac{3}{2}} dx + \frac{\sqrt{2}}{3} \int_0^1 x^{\frac{1}{2}-1} (1-x)^{\frac{5}{2}-1} dx = \sqrt{2} B(\frac{3}{2}, \frac{3}{2}) + \frac{\sqrt{2}}{3} B(\frac{1}{2}, \frac{5}{2}) = \frac{\pi}{2\sqrt{2}}$$

# Neka je  $S$  površina tijela koje je dobijeno presjekom dva cilindra  $S_1 = \{(x, y, z) \in \mathbb{R}^3 \mid x^2 + z^2 = a^2, y \in \mathbb{R}\}$  i  $S_2 = \{(x, y, z) \in \mathbb{R}^3 \mid y^2 + z^2 = a^2, x \in \mathbb{R}\}$ . Izračunati površinu dobijenog tijela.

Rj:  $P = \iint_S dS$  Skicirajmo  $S_1$  i  $S_2$ , pa skicirajmo njihov presjek.

$S_1: x^2 + z^2 = a^2$  u ravni:  $xOz$

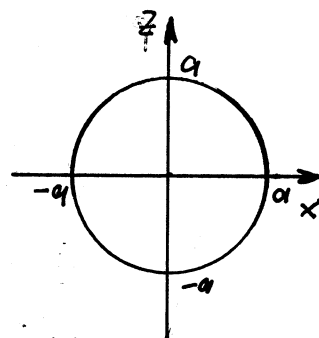

U prostoru, u prvom oktantu:

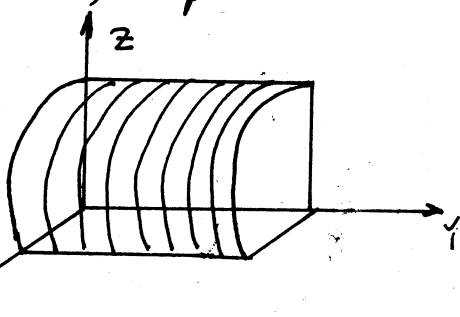

$S_2$  u prvom oktantu:

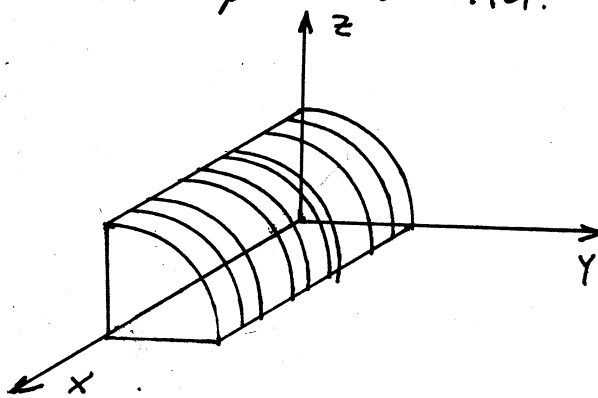

Presjek  $S_1 \cap S_2$  će kao rezultat dati tijelo koje je simetrično u odnosu na sve tri ravni  $xOy$ ,  $xOz$  i  $yOz$ .

$\frac{1}{8}$  dijela tijela će se nalaziti u prvom oktantu:

Primjetimo da je i ovo tijelo simetrično u odnosu na pravu  $y=x$  pa imamo

$$P = \frac{1}{16} \iint_D \sqrt{1 + (z'_x)^2 + (z'_y)^2} dx dy$$

gdje je  $D: \begin{cases} 0 \leq x \leq a \\ 0 \leq y \leq x \end{cases}$

$$z^2 = a^2 - x^2 \quad \text{tj.} \quad z = \sqrt{a^2 - x^2}$$

$$z'_x = \frac{-x}{\sqrt{a^2 - x^2}}, \quad z'_y = 0$$

$$1 + (z'_x)^2 + (z'_y)^2 = 1 + \frac{x^2}{a^2 - x^2} = \frac{a^2}{a^2 - x^2}$$

$$P = 16a \int_0^a \frac{dx}{\sqrt{a^2 - x^2}} \int_0^x dy = 16a \int_0^a \frac{x dx}{\sqrt{a^2 - x^2}} = \left| \begin{array}{l} a^2 - x^2 = t \\ -2x dx = dt \\ x dx = -\frac{1}{2} dt \end{array} \right| = \dots = 16a \sqrt{a^2 - x^2} \Big|_a^0 = 16a^2$$

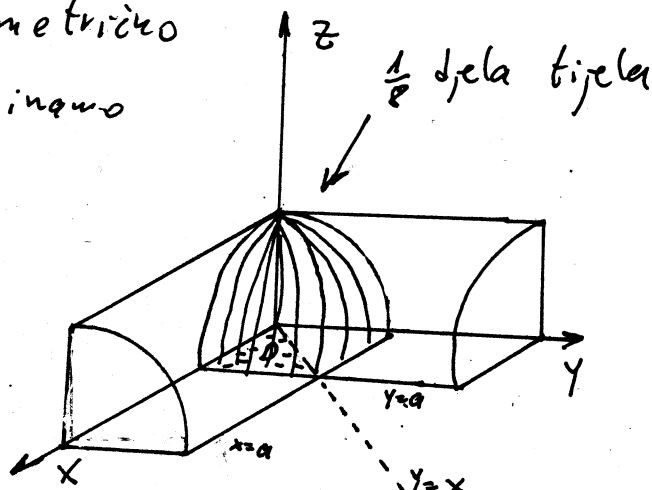

tražena površina

# Izračunati površinu djela sfere

$$S = \{(x, y, z) \in \mathbb{R}^3 \mid x^2 + y^2 + z^2 = a^2\}$$

koji se nalazi u unutrašnjosti cilindra

$$S_1 = \{(x, y, z) \in \mathbb{R}^3 \mid \frac{x^2}{a^2} + \frac{y^2}{b^2} = 1, z \in \mathbb{R}\}, \quad b \leq a$$

b) Skicirajte sferu  $S$  i cilindar  $S_1$ .

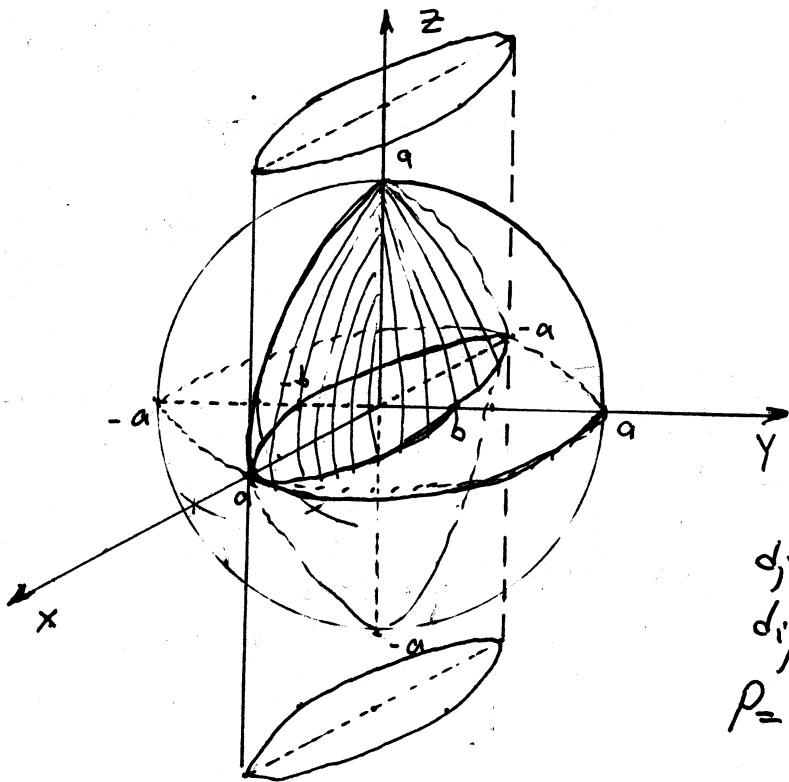

Cilindrična površina u presjeku sa sferom, isjeka iz nje simetričnu površ u odrazu na ravan  $xOy$ . Ta dva simetrična dijela označimo sa  $l_1$  i  $l_2$ . Svaka od ova dva dijela, koordinatne ravnj  $xOz$  i  $yOz$  ih dijele na četiri jednaka dijela.

$$P = \iint_S dS \quad \text{gdje je } S \text{ površina}$$

djela sfere ograničena cilindrom.

$$S: x^2 + y^2 + z^2 = a^2$$

$$z = \pm \sqrt{a^2 - x^2 - y^2}$$

Zbog navedene simetričnosti posmatraću sferu samo u prvom oktantu

$$z = \sqrt{a^2 - x^2 - y^2}$$

$$z'_x = \frac{-x}{\sqrt{a^2 - x^2 - y^2}}, \quad z'_y = \frac{-y}{\sqrt{a^2 - x^2 - y^2}}$$

$$\iint_S dS = \iint_D \sqrt{1 + (z'_x)^2 + (z'_y)^2} dx dy \quad \text{gdje je } D \text{ projekcija površi } S \text{ na } xOy \text{ ravan}$$

$$1 + (z'_x)^2 + (z'_y)^2 = 1 + \frac{x^2}{a^2 - x^2 - y^2} + \frac{y^2}{a^2 - x^2 - y^2} = \frac{a^2}{a^2 - x^2 - y^2}$$

$$P = 8 \iint_D \sqrt{\frac{a^2}{a^2 - x^2 - y^2}} dx dy = 8a \iint_D \frac{dx dy}{\sqrt{a^2 - x^2 - y^2}} = 8a \iint_0^1 \frac{dx dy}{\sqrt{a^2 - x^2 - y^2}}$$

$\frac{x^2}{a^2} + \frac{y^2}{b^2} \leq 1$   
 $a > 0, b > 0$

$\frac{x^2}{a^2} + \frac{y^2}{b^2} \leq 1, a > 0, b > 0$

gdje je  $D: \begin{cases} \frac{x^2}{a^2} + \frac{y^2}{b^2} \leq 1 \\ x \geq 0, y \geq 0 \end{cases}$  ili drugačije napisano  $D: \begin{cases} 0 \leq x \leq a \\ 0 \leq y \leq \frac{b}{a} \sqrt{a^2 - x^2} \end{cases}$

$$\frac{y^2}{b^2} \leq 1 - \frac{x^2}{a^2}$$

$$y^2 \leq \frac{b^2}{a^2} (a^2 - x^2)$$

$$y = \pm \frac{b}{a} \sqrt{a^2 - x^2}$$

$$P = 8a \int_0^a dx \int_0^{\frac{b}{a} \sqrt{a^2 - x^2}} \frac{dy}{\sqrt{a^2 - x^2 - y^2}} = 8a \int_0^a \left( \arcsin \frac{y}{\sqrt{a^2 - x^2}} \Big|_{y=0}^{y=\frac{b}{a} \sqrt{a^2 - x^2}} \right) dx$$

ovaj broj je dy

$$\int \frac{dx}{\sqrt{a^2 - x^2}} = \arcsin \frac{x}{a} + c \quad \Big| \quad = 8a \int_0^a \left( \arcsin \frac{b}{a} - \underbrace{\arcsin 0}_{=0} \right) dx =$$

$$= 8a \arcsin \frac{b}{a} \int_0^a dx = 8a^2 \arcsin \frac{b}{a} \quad \text{tražena površina}$$



# Zadaci za vježbu i rješenja

#

Izračunati površinu površi  $S$ , ako je  $S$  dio površi  $z = \frac{x+y}{x^2+y^2}$

između cilindara  $x^2 + y^2 = 1$  i  $x^2 + y^2 = 2$  u I oktantu.

**Rj.**

Za površ  $z = \frac{x+y}{x^2+y^2}$  imamo

$$\frac{\partial z}{\partial x} = \frac{y^2 - 2xy - x^2}{(x^2 + y^2)^2}, \quad \frac{\partial z}{\partial y} = \frac{x^2 - 2xy - y^2}{(x^2 + y^2)^2},$$

pa je

$$P = \iint_S dS = \iint_D \sqrt{1 + \left[ \frac{y^2 - 2xy - x^2}{(x^2 + y^2)^2} \right]^2 + \left[ \frac{x^2 - 2xy - y^2}{(x^2 + y^2)^2} \right]^2} dx dy,$$

gdje je  $D: 1 \leq x^2 + y^2 \leq 2$ .

Uvedimo polarne koordinate:  $x = \rho \cos \varphi$ ,  $y = \rho \sin \varphi$ . Imaćemo:

$$P = \iint_D \sqrt{1 + \frac{1}{\rho^4} (-\cos 2\varphi - \sin 2\varphi)^2 + \frac{1}{\rho^4} (\cos 2\varphi - \sin 2\varphi)^2} d\rho d\varphi =$$

$$= \int_0^{\pi/2} d\varphi \int_1^{\sqrt{2}} \frac{\sqrt{\rho^4 + 2}}{\rho^4} \cdot \rho^3 d\rho = \frac{\pi}{2} \int_{\sqrt{3}}^{\sqrt{6}} \frac{t^2}{2(t^2 - 2)} dt =$$

$$\left( 2 + \rho^4 = t^2, \quad \rho^3 d\rho = \frac{1}{2} t dt \right)$$

$$= \frac{\pi}{4} \int_{\sqrt{3}}^{\sqrt{6}} \left( 1 + \frac{2}{t^2 - 2} \right) dt = \frac{\pi}{4} \left( t + \frac{1}{\sqrt{2}} \ln \frac{t - \sqrt{2}}{t + \sqrt{2}} \right) \Big|_{\sqrt{3}}^{\sqrt{6}} =$$

$$= \frac{\pi}{4} \left[ \sqrt{6} - \sqrt{3} - \frac{1}{\sqrt{2}} \ln \left( \frac{\sqrt{6} - \sqrt{2}}{\sqrt{6} + \sqrt{2}} \cdot \frac{\sqrt{3} + \sqrt{2}}{\sqrt{3} - \sqrt{2}} \right) \right].$$

#

Izračunati površinu površi  $S$ , ako je  $S$  dio površi  $x^2 + y^2 + z^2 = R^2$  koji se nalazi van cilindra  $(x^2 + y^2)^2 = R^2(x^2 - y^2)$ .

Rj.

Površ  $S: x^2 + y^2 + z^2 = R^2$  isječena cilindrom  $(x^2 + y^2)^2 = R^2(x^2 - y^2)$  simetrična je odnosu na koordinatne ravni (sl. 70), pa je

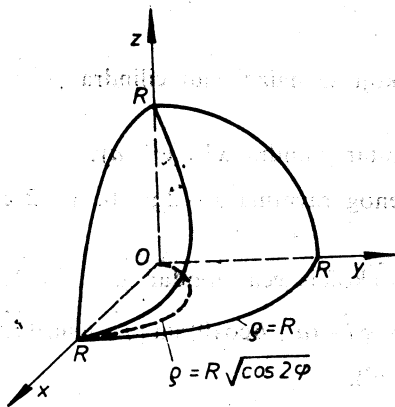

Sl. 70

$$\begin{aligned} P &= 8 \iint_{S_1} dS = \\ &= 8 \iint_{S_1} \sqrt{1 + \left(\frac{x}{z}\right)^2 + \left(\frac{y}{z}\right)^2} dx dy = \\ &= 8 \iint_{D_1} \frac{R}{\sqrt{R^2 - (x^2 + y^2)}} dx dy, \end{aligned}$$

gdje je  $S_1$  dio površi  $S$  u I oktantu. Uvedimo polarne koordinate. Biće

$$P = 8R \int_{\pi/4}^{\pi/2} d\varphi \int_0^R \frac{\rho d\rho}{\sqrt{R^2 - \rho^2}} + 8R \int_0^{\pi/4} d\varphi \int_{R\sqrt{\cos 2\varphi}}^R \frac{\rho d\rho}{\sqrt{R^2 - \rho^2}}.$$

$$\left( \text{Može i ovako: } P = 8R \int_0^{\pi/2} d\varphi \int_0^R \frac{\rho d\rho}{\sqrt{\rho^2 - \rho^2}} - 8R \int_0^{\pi/4} d\varphi \int_0^{R\sqrt{\cos 2\varphi}} \frac{\rho d\rho}{\sqrt{R^2 - \rho^2}} \right)$$

$$\text{Dakle, } P = 8R \int_0^{\pi/4} \left[ -\sqrt{R^2 - \rho^2} \right]_{R\sqrt{\cos 2\varphi}}^R d\varphi + 8R \cdot \frac{\pi}{4} \left[ -\sqrt{R^2 - \rho^2} \right]_0^R.$$

$$\text{tj. } P = R^2(8\sqrt{2} - 8 + 2\pi).$$

#

Izračunati površinu površi  $S$ , ako je:

250.  $S$  dio sfere  $x^2 + y^2 + z^2 = a^2$  unutar cilindra  $x^2 + y^2 = ay$ .

251.  $S$  dio cilindra  $x^2 = 2z$  odsječenog ravnima  $x - 2y = 0$ ,  $y = 2x$  i  $x = 2\sqrt{2}$ .

252.  $S$  dio površi  $y = x^2 + z^2$  u I oktantu koji isijeca cilindar  $x^2 + z^2 = 1$ .

253.  $S$  površ torusa  $\vec{r} = (a + b \cos \theta) \cos \varphi \vec{i} + (a + b \cos \theta) \sin \varphi \vec{j} + b \sin \theta \vec{k}$ .

Rj.

250.  $P = 4a^2 \left( \frac{\pi}{2} - 1 \right)$ .

251.  $P = 13$ .

252.  $P = \frac{(5\sqrt{5} - 1)}{24}$ .

253.  $P = 4ab\pi^2 \left( \text{Uzeti } P = \iint_S dS = \iint_D \left| \frac{\partial \vec{r}}{\partial \varphi} \times \frac{\partial \vec{r}}{\partial \theta} \right| d\varphi d\theta; \right.$

$D: 0 < \varphi \leq 2\pi, 0 \leq \theta \leq 2\pi \left. \right)$ .

#

Izračunati površinu površi  $S$ , ako je  $S$  površ  $(x^2 + y^2 + z^2)^2 = a^2(x^2 + y^2)$ .

**Rj.**

Smjenom  $x = \rho \cos \varphi \sin \theta$ ,  $y = \rho \sin \varphi \sin \theta$ ,  $z = \rho \cos \theta$  dobija se jednačina  $\rho = a \sin \theta$ . Uvrštavajući ovu vrijednost  $\rho = \rho(\varphi, \theta)$  u jednačine

$x = x(\rho, \varphi, \theta)$ ,  $y = y(\rho, \varphi, \theta)$ ,  $z = z(\rho, \varphi, \theta)$  dobijaju se parametarske jednačine površi

$$x = a \sin^2 \theta \cos \varphi = x(\varphi, \theta)$$

$$y = a \sin^2 \theta \sin \varphi = y(\varphi, \theta)$$

$$z = \frac{a}{2} \sin 2\theta = z(\varphi, \theta).$$

Za izračunavanje površine koristićemo vezu

$$\iint_S dS = \iint_D \sqrt{A^2 + B^2 + C^2} d\varphi d\theta, \text{ pri čemu je}$$

$$A = \frac{D(y, z)}{D(\varphi, \theta)}, \quad B = \frac{D(z, x)}{D(\varphi, \theta)}, \quad C = \frac{D(x, y)}{D(\varphi, \theta)}.$$

Biće:

$$A = a^2 \sin^2 \theta \cos \varphi \cos 2\theta$$

$$B = a^2 \sin^2 \theta \sin \varphi \cos 2\theta$$

$$C = -2a^2 \cos \theta \sin^3 \theta$$

i zatim

$$A^2 + B^2 + C^2 = a^4 \sin^4 \theta, \quad \sqrt{A^2 + B^2 + C^2} = a^2 \sin^2 \theta.$$

Sada je

$$P = a^2 \int_0^{2\pi} d\varphi \int_0^{\pi} \sin^2 \theta d\theta = 2\pi a^2 \int_0^{\pi} \sin^2 \theta d\theta = \pi^2 a^2.$$

#

Izračunati površinu površi  $S$ , ako je  $S$  površ (Vivanijevog) tijela

$$V = \{(x, y, z) : x^2 + y^2 + z^2 \leq R^2, x^2 + y^2 \leq Rx\}.$$

**Rj.**

Tijelo je simetrično u odnosu na ravan  $z=0$ , pa je  $P = 2P_S + 2P_C$ , pri čemu je  $P_S$  površina gornjeg dijela sfere, a  $P_C$  površina gornjeg dijela cilindra. Biće

$$P_S = \iint_{S'} \sqrt{1 + z_x'^2 + z_y'^2} dx dy = R \iint_{S'} \frac{dx dy}{\sqrt{R^2 - (x^2 + y^2)}}.$$

Oblast  $S'$  je krug  $x^2 + y^2 \leq Rx$ . Uvodeći polarne koordinate dobijamo se

$$P_S = R \int_{-\frac{\pi}{2}}^{\frac{\pi}{2}} d\varphi \int_0^{R \cos \varphi} \frac{\rho d\rho}{\sqrt{R^2 - \rho^2}} = 2R^2 \left( \frac{\pi}{2} - 1 \right).$$

Površinu cilindra tražimo pomoću krivolinijskog integrala:  $P_C = \int_l z ds$ , pri čemu je  $l$  kružnica  $x^2 + y^2 = Rx$ , a  $z = \sqrt{R^2 - (x^2 + y^2)} = \sqrt{R^2 - Rx}$ .

Ako jednačinu kružnice  $l$  napišemo u parametarskom obliku

$x = \frac{R}{2}(1 - \cos \varphi)$ ,  $y = \frac{R}{2} \sin \varphi$ , dobiće se  $ds = \frac{R}{2} d\varphi$ ,  $\varphi \in (0, 2\pi)$ , i zatim

$$\begin{aligned} P_C &= \frac{R}{2} \int_0^{2\pi} \sqrt{R^2 - \frac{R^2}{2}(1 + \cos \varphi)} d\varphi = \frac{R^2}{2} \int_0^{2\pi} \sqrt{1 - \cos^2 \varphi} d\varphi = \\ &= \frac{R^2}{2} \int_0^{2\pi} \sqrt{\sin^2 \varphi} d\varphi = \frac{R^2}{2} \int_0^{2\pi} |\sin \varphi| d\varphi = \\ &= \frac{R^2}{2} \int_0^{\pi} \sin \varphi d\varphi - \frac{R^2}{2} \int_{\pi}^{2\pi} \sin \varphi d\varphi = 2R^2. \end{aligned}$$

Slijedi

$$P = 2R^2.$$

# Stoksova formula

Dat je krivolinijski integral  $\int_C P(x,y,z) dx + Q(x,y,z) dy + R(x,y,z) dz$

gdje je  $C$  kontura u prostoru.

Stoksova formula glasi:

$$\int_C P(x,y,z) dx + Q(x,y,z) dy + R(x,y,z) dz = \iint_S \begin{vmatrix} \cos \alpha & \cos \beta & \cos \gamma \\ \frac{\partial}{\partial x} & \frac{\partial}{\partial y} & \frac{\partial}{\partial z} \\ P & Q & R \end{vmatrix} dS$$

površinski integral prve vrste

$$\int_C P(x,y,z) dx + Q(x,y,z) dy + R(x,y,z) dz = \iint_S \begin{vmatrix} dy dz & dx dz & dx dy \\ \frac{\partial}{\partial x} & \frac{\partial}{\partial y} & \frac{\partial}{\partial z} \\ P & Q & R \end{vmatrix}$$

površinski integral druge vrste

gdje je  $S$  površina u prostoru ograničena konturom  $C$   
a  $\vec{n} = (\cos \alpha, \cos \beta, \cos \gamma)$  jedinični vektor normale na površinu  $S$ .

$$\begin{vmatrix} \cos \alpha & \cos \beta & \cos \gamma \\ \frac{\partial}{\partial x} & \frac{\partial}{\partial y} & \frac{\partial}{\partial z} \\ P & Q & R \end{vmatrix} = \left( \frac{\partial R}{\partial y} - \frac{\partial Q}{\partial z} \right) \cos \alpha + \left( \frac{\partial P}{\partial z} - \frac{\partial R}{\partial x} \right) \cos \beta + \left( \frac{\partial Q}{\partial x} - \frac{\partial P}{\partial y} \right) \cos \gamma$$

Vidimo da Stoksova formula povezuje krivolinijski integral druge vrste sa površinskim integralom prve i druge vrste.

Ranije smo spomenuli Greenovu formulu koja povezuje krivolinijski integral druge vrste sa dvostrukim integralom, Formula Gauss-Ostrogradski povezuje površinski integral druge vrste sa trostrukim integralom.

(#) Integral  $I = \int_L (y^2 + z^2) dx + (x^2 + z^2) dy + (x^2 + y^2) dz$

uzet po nekoj zatvorenoj konturi  $L$ , pretvoriti pomoću formule Stokesa u površinski integral, nad površinom koju zatvara spomenuta kontura.

Rj.

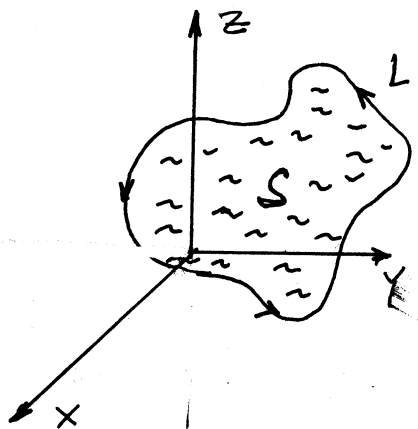

$$\int_L P dx + Q dy + R dz = \iint_S \begin{vmatrix} dy dz & dx dz & dx dy \\ \frac{\partial}{\partial x} & \frac{\partial}{\partial y} & \frac{\partial}{\partial z} \\ P & Q & R \end{vmatrix}$$

$$R(x, y, z) = x^2 + y^2$$

$$P(x, y, z) = y^2 + z^2$$

$$Q(x, y, z) = x^2 + z^2$$

$$\frac{\partial R}{\partial y} = 2y$$

$$\frac{\partial Q}{\partial z} = 2z$$

$$\frac{\partial R}{\partial x} = 2x$$

$$\frac{\partial P}{\partial z} = 2z$$

$$\frac{\partial Q}{\partial x} = 2x$$

$$\frac{\partial P}{\partial y} = 2y$$

$$I = \iint_S (2y - 2z) dy dz - (2x - 2z) dx dz + (2x - 2y) dx dy =$$

$$= 2 \iint_S (y - z) dy dz + (z - x) dx dz + (x - y) dx dy$$

# Izračunati krivolinijski integral  $-\int_C y^2 dx + z^2 dy + x^2 dz$

pri čemu je  $c$  kontura  $\triangle ABC$  gdje su tačke  $A(a, 0, 0)$ ,  $B(0, b, 0)$  i  $C(0, 0, c)$ ,  $a, b, c > 0$ .

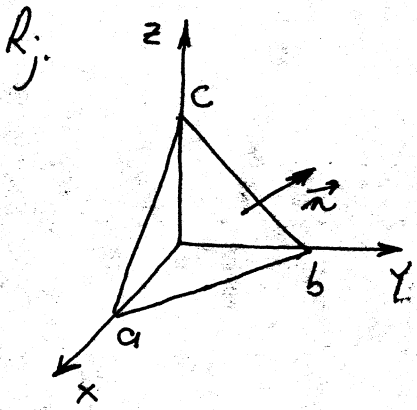

Stoksova formula 
$$-\iint_S \begin{vmatrix} dydz & dzdx & dxdy \\ \frac{\partial}{\partial x} & \frac{\partial}{\partial y} & \frac{\partial}{\partial z} \\ P & Q & R \end{vmatrix}$$

$$-\int_C y^2 dx + z^2 dy + x^2 dz$$

$$P = y^2, \quad Q = z^2, \quad R = x^2$$

$$\frac{\partial Q}{\partial x} = 0, \quad \frac{\partial P}{\partial y} = 2y, \quad \frac{\partial R}{\partial z} = 0, \quad \frac{\partial Q}{\partial z} = 2z$$

$$\frac{\partial R}{\partial x} = 2x, \quad \frac{\partial P}{\partial z} = 0$$

$$\begin{vmatrix} dydz & dzdx & dxdy \\ \frac{\partial}{\partial x} & \frac{\partial}{\partial y} & \frac{\partial}{\partial z} \\ P & Q & R \end{vmatrix} = -2z dydz - 2x dzdx - 2y dxdy$$

$$-\int_C y^2 dx + z^2 dy + x^2 dz = 2 \iint_S (z dydz + x dzdx + y dxdy)$$

$S$  oblast ograničena  $\triangle ABC$

Izračunajmo  $\iint_S z dydz$ . Površinu  $S$  projicirajmo na  $yOz$  ravan:

$$\frac{y}{b} + \frac{z}{c} = 1$$

$$cy + bz = bc$$

$$bz = bc - cy$$

$$z = c - \frac{c}{b}y = \frac{c}{b}(b-y)$$

Ugao koji zaklapa vektor normale  $\vec{n}$  na površinu  $S$  je izmisliti  $0; \frac{\pi}{2}$ .

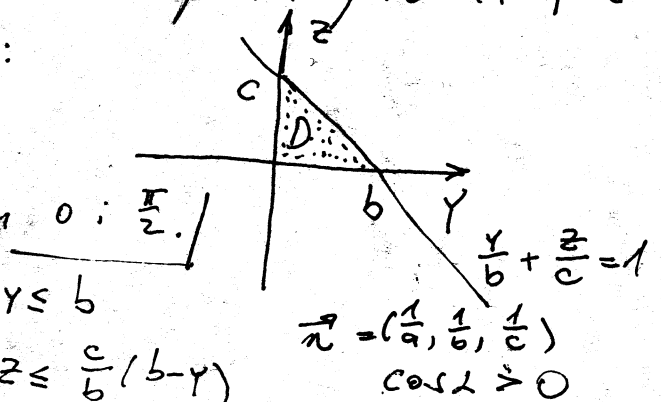

$$D: \begin{cases} 0 \leq y \leq b \\ 0 \leq z \leq \frac{c}{b}(b-y) \end{cases}$$

$$\vec{n} = \left(\frac{1}{a}, \frac{1}{b}, \frac{1}{c}\right)$$

$$\cos \alpha \geq 0$$

$$\iint_S z dydz = \int_0^b \int_0^{\frac{c}{b}(b-y)} z dz dy = \int_0^b \left[ \frac{1}{2} z^2 \right]_0^{\frac{c}{b}(b-y)} dy = \frac{1}{2} \left(\frac{c}{b}\right)^2 \int_0^b (b-y)^2 dy$$

$$= \int_{y=0}^{y=b} \begin{matrix} b-y=t \\ -dy=dt \\ dy=-dt \end{matrix} \left[ \frac{1}{2} \frac{c^2}{b^2} \int t^2 dt = \frac{1}{2} \cdot \frac{c^2}{b^2} \frac{t^3}{3} \right]_0^b = \frac{1}{2} \cdot \frac{bc^2}{3}$$

Analogno izračunamo  $\iint_S x dzdx = \frac{1}{2} \cdot \frac{a^2 c}{3}$  i  $\iint_S y dxdy = \frac{1}{2} \cdot \frac{ab^2}{3} \Rightarrow I = \frac{ab^2 + bc^2 + ca^2}{3}$



# Izračunati krivolinijski integral  $\int_C y dx + z dy + x dz$   
 ako je  $C$  krug dobijen presjekom  $C$  sfere  $x^2 + y^2 + z^2 = a^2$   
 i ravni  $x + y + z = 0$ .

Rj.

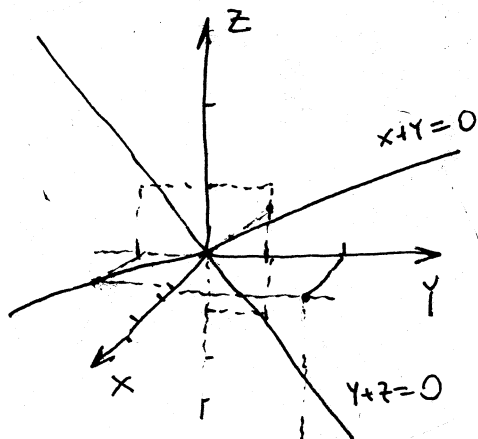
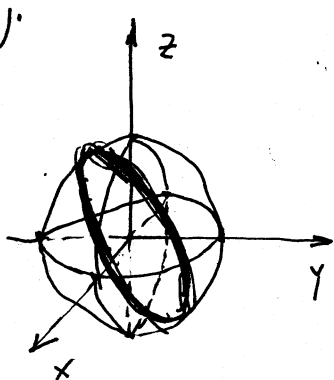

Stokrova formula

$$\int_C y dx + z dy + x dz = \iint_S \begin{vmatrix} \cos \alpha & \cos \beta & \cos \gamma \\ \frac{\partial}{\partial x} & \frac{\partial}{\partial y} & \frac{\partial}{\partial z} \\ P & Q & R \end{vmatrix} dS$$

$$\frac{\partial Q}{\partial x} = 0 \quad \frac{\partial P}{\partial y} = 1 \quad P = y$$

$$Q = z \quad R = x$$

$S$  je površina ograničena krugom

$$= \left( \frac{\partial R}{\partial y} - \frac{\partial Q}{\partial z} \right) \cos \alpha - \left( \frac{\partial R}{\partial x} - \frac{\partial P}{\partial z} \right) \cos \beta + \left( \frac{\partial Q}{\partial x} - \frac{\partial P}{\partial y} \right) \cos \gamma$$

$$\begin{vmatrix} \cos \alpha & \cos \beta & \cos \gamma \\ \frac{\partial}{\partial x} & \frac{\partial}{\partial y} & \frac{\partial}{\partial z} \\ P & Q & R \end{vmatrix}$$

$$\frac{\partial R}{\partial y} = 0 \quad \frac{\partial Q}{\partial z} = 1 \quad \frac{\partial R}{\partial x} = 1 \quad \frac{\partial P}{\partial z} = 0$$

$$\int_C y dx + z dy + x dz = \iint_S (-\cos \alpha - \cos \beta - \cos \gamma) dS$$

gdje je  $\vec{n}_0 = (\cos \alpha, \cos \beta, \cos \gamma)$  vektor (jedinični) normale na površinu  $S$

$$x + y + z = 0$$

$\vec{n} = (1, 1, 1)$  vektor normale na ravninu  $x + y + z = 0$  (a time i na našu površinu  $S$ )

$$|\vec{n}| = \sqrt{1+1+1} = \sqrt{3}$$

$$\vec{n}_0 = \left( \frac{1}{\sqrt{3}}, \frac{1}{\sqrt{3}}, \frac{1}{\sqrt{3}} \right)$$

$\cos \alpha \quad \cos \beta \quad \cos \gamma$

$$\iint_S (-\cos \alpha - \cos \beta - \cos \gamma) dS = \iint_S \left( -\frac{1}{\sqrt{3}} - \frac{1}{\sqrt{3}} - \frac{1}{\sqrt{3}} \right) dS = -\frac{3}{\sqrt{3}} \iint_S dS$$

$\iint_S dS$  je površina oblasti  $S$  ( $S$  je krug poluprečnika  $a$   $P_{krug} = a^2 \pi$ )

$$\int_C y dx + z dy + x dz = -\frac{3}{\sqrt{3}} a^2 \pi = -\sqrt{3} a^2 \pi$$

⊕ Uz pomoć formule Stoksa, izračunati krivolinijski integral  $K = \oint e^x dx + z(x^2+y^2)^{\frac{3}{2}} dy + yz^3 dz$  gdje je

$\rho$ -zakrivljena linija OCBAO (vidi sliku)

dobijena presjekom površine

$$z = \sqrt{x^2+y^2}, \quad x=0, \quad x=2, \quad y=0, \quad y=1.$$

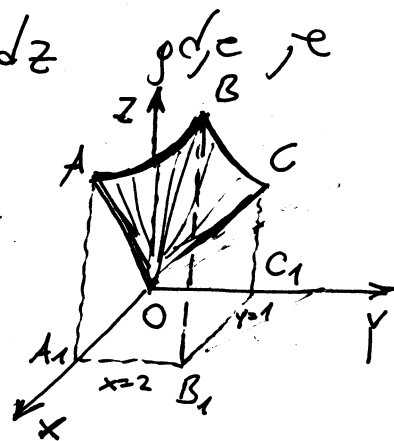

h)  $z = \sqrt{x^2+y^2}$  je čunj iznad  $xOy$  ravni



$x=0, x=2$  su ravni paralelne sa  $yOz$  ravni

$y=0, y=1$  su ravni paralelne sa  $xOz$  ravni

Stoksova formula glasi

$$\int_C P(x,y,z) dx + Q(x,y,z) dy + R(x,y,z) dz = \iint_S \begin{vmatrix} dydz & dx dz & dx dy \\ \frac{\partial}{\partial x} & \frac{\partial}{\partial y} & \frac{\partial}{\partial z} \\ P & Q & R \end{vmatrix}$$

površinski integral druge vrste

$$P = e^x, \quad \frac{\partial P}{\partial y} = 0, \quad \frac{\partial P}{\partial z} = 0$$

$$Q = z(x^2+y^2)^{\frac{3}{2}}, \quad \frac{\partial Q}{\partial x} = z \cdot \frac{3}{2}(x^2+y^2)^{\frac{1}{2}} \cdot 2x = 3xz\sqrt{x^2+y^2}, \quad \frac{\partial Q}{\partial z} = (x^2+y^2)^{\frac{3}{2}}$$

$$R = yz^3, \quad \frac{\partial R}{\partial x} = 0, \quad \frac{\partial R}{\partial y} = z^3$$

$$K = \oint e^x dx + z(x^2+y^2)^{\frac{3}{2}} dy + yz^3 dz = \left| \begin{array}{l} \text{formula Stoksa} \\ \end{array} \right| =$$

$$= \iint_S \begin{vmatrix} dydz & dx dz & dx dy \\ \frac{\partial}{\partial x} & \frac{\partial}{\partial y} & \frac{\partial}{\partial z} \\ e^x & z(x^2+y^2)^{\frac{3}{2}} & yz^3 \end{vmatrix} = \iint_S \underbrace{(z^3 - (x^2+y^2)^{\frac{3}{2}})}_{=0} dy dz - (0-0) dx dz$$

$$+ (3xz\sqrt{x^2+y^2} - 0) dx dy = \iint_S 3xz\sqrt{x^2+y^2} dx dy$$

površinski  
integral  
II vrste

Tj. dobili smo 
$$K = \iint_S 3xz \sqrt{x^2+y^2} \, dx \, dy$$

Kako naša data kriva pravi površinu  $S: z = \sqrt{x^2+y^2}$  u prvom oktantu imamo

$$K = \iint_S 3x(x^2+y^2) \, dx \, dy$$

Prisjetimo se kako se računa površinski integral II vrste  
 npr.  $I = \iint_S R(x,y,z) \, dx \, dy$ . Neka je  $\vec{n}$  vektor normale na površ  $S$ ,  
 neka je  $\gamma$  ugao koji  $\vec{n}$  gradi sa z-osom, i neka  
 je  $D$  projekcija površi  $S$  na  $xOy$  ravan. Tada  

$$I = \iint_S R(x,y,z) \, dx \, dy = \pm \iint_D R(x,y, z(x,y)) \, dx \, dy$$
 gdje predznak  
 ispred integrala zavisi od  $\cos \gamma$  (za  $\cos \gamma > 0$  +,  $\cos \gamma < 0$  -)

Mi posmatramo vanjsku stranu površi, iz čega možemo  
 zaključiti (sa slike) da je  $\gamma \in (\frac{\pi}{2}, \pi)$  pa je  $\cos \gamma < 0$ .  
 Projekcija  $D$  površi  $S$  je data u sklopu zadatka (vidi sliku)  
 $(\square A_1 B_1 C_1 O)$

$$D: \begin{cases} 0 \leq x \leq 2 \\ 0 \leq y \leq 1 \end{cases}$$

$$K = \iint_S 3x(x^2+y^2) \, dx \, dy = - \iint_D 3x(x^2+y^2) \, dx \, dy =$$

$$= -3 \int_0^1 dy \int_0^2 (x^3 + xy^2) \, dx = -3 \int_0^1 \left( \frac{1}{4} x^4 \Big|_0^2 + \frac{1}{2} x^2 y^2 \Big|_0^2 \right) dy =$$

$$= -3 \int_0^1 (4 + 2y^2) \, dy = -3 \left( 4y \Big|_0^1 + \frac{2}{3} y^3 \Big|_0^1 \right) = -12 - 2 = -14$$

traženo  
rešenje

# Zadaci za vježbu

3894. Integral  $\int_L (y^2 + z^2) dx + (x^2 + z^2) dy + (x^2 + y^2) dz$ , uzet po nekoj zatvorenoj konturi  $L$ , primenom Štoksove formule transformisati u integral po površini „razapetoj“ nad tom konturom.

3895. Izračunati integral  $\int_L x^2 y^3 dx + dy + z dz$  po krugu  $x^2 + y^2 = R^2$ ,  $z = 0$ , na dva načina: a) neposredno, i b) koristeći Štoksovu formulu, uzimajući za površinu  $S$  polusferu  $z = +\sqrt{R^2 - x^2 - y^2}$ . (Integracija po krugu u ravni  $xOy$  računa se u pozitivnom smeru obilaženja).

## Rješenja

$$3894. \quad 2 \iint_S (x-y) dx dy + (y-z) dy dz + (z-x) dx dz.$$

$$3895. \quad -\frac{\pi R^6}{8}.$$

# Formula Gauss-Ostrogradski

Ova formula daje vezu između površinskog integrala druge vrste i trostrukog integrala:

$$\iint P(x,y,z) dy dz + Q(x,y,z) dx dz + R(x,y,z) dx dy = \\ = \iiint_{\Omega} \left( \frac{\partial P}{\partial x} + \frac{\partial Q}{\partial y} + \frac{\partial R}{\partial z} \right) dx dy dz$$

gdje je  $\Omega$  oblast u prostoru ograničena datom površinom  $S$  ( $S$  je zatvorena površina).

① Izračunati  $\iint_S xy dx dy + yz dy dz + zx dz dx$  gdje je  $S$  bilo koja zatvorena površ.

Rj.

$$\iint_S yz dy dz + zx dx dz + xy dx dy = \iint_S P dy dz + Q dx dz + R dx dy \\ \stackrel{\text{Formula Gauss-Ostrv.}}{=} \iiint_{\Omega} \left( \frac{\partial P}{\partial x} + \frac{\partial Q}{\partial y} + \frac{\partial R}{\partial z} \right) dx dy dz$$

gdje je  $\Omega$  oblast u prostoru ograničena datom površinom  $S$ .

$$S, \quad \frac{\partial P}{\partial x} = 0; \quad \frac{\partial Q}{\partial y} = 0, \quad \frac{\partial R}{\partial z} = 0$$

$$\iint_S yz dy dz + zx dx dz + xy dx dy = \iiint_{\Omega} 0 dx dy dz =$$

$$\Omega: \begin{cases} a \leq x \leq b \\ c \leq y \leq d \\ e \leq z \leq f \end{cases} = \int_a^b dx \int_c^d dy \int_e^f 0 dz = 0$$

# Uz pomoć formule Gauss-Ostrogradski izračunati površinski integral  $I = \oint_S 4x^3 dy dz + 4y^3 dx dz - 6z^4 dx dy$

gdje je  $S$  vanjska strana cilindra  $x^2 + y^2 = a^2$  koji se nalazi između ravni  $z=0$  i  $z=h$ .

Skicirajmo dati cilindar

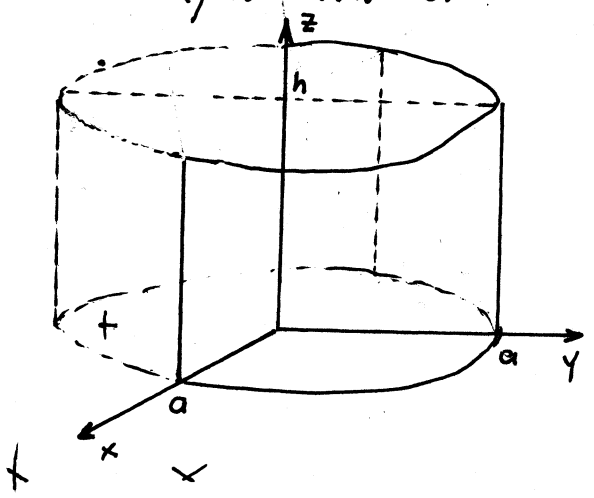

Prisjetimo se formule Gauss-Ostrogradski

$$\oint_S P(x,y,z) dy dz + Q(x,y,z) dx dz + R(x,y,z) dx dy = \iiint_{\Omega} \left( \frac{\partial P}{\partial x} + \frac{\partial Q}{\partial y} + \frac{\partial R}{\partial z} \right) dx dy dz$$

$\Omega$  - unutrašnjost objekta  $S$

$$\begin{aligned} P(x,y,z) &= 4x^3 & \frac{\partial P}{\partial x} &= 12x^2 \\ Q(x,y,z) &= 4y^3 & \frac{\partial Q}{\partial y} &= 12y^2 \\ R(x,y,z) &= -6z^4 & \frac{\partial R}{\partial z} &= -24z^3 \end{aligned}$$

$$\oint_S 4x^3 dy dz + 4y^3 dx dz - 6z^4 dx dy = 12 \iiint_{\Omega} (x^2 + y^2 - 2z^3) dx dy dz =$$

$$= \left. \begin{array}{l} \text{ uvedimo cilindrične koordinate} \\ x = r \cos \varphi \\ y = r \sin \varphi \\ z = z \\ dx dy dz = r dr d\varphi dz \\ x^2 + y^2 = \dots = r^2 \end{array} \right| \begin{array}{l} \Omega \xrightarrow{\text{transformacije}} \Omega' \\ 0 \leq r \leq a \\ 0 \leq \varphi \leq 2\pi \\ 0 \leq z \leq h \end{array} = 12 \iiint_{\Omega'} (r^2 - 2z^3) r dr d\varphi dz =$$

$$= 12 \int_0^{2\pi} d\varphi \int_0^a dr \int_0^h (r^3 - 2rz^3) dz = 12 \int_0^{2\pi} d\varphi \int_0^a \left( r^3 z \Big|_0^h - 2r \cdot \frac{1}{4} z^4 \Big|_0^h \right) dr$$

$$= 12 \int_0^{2\pi} d\varphi \int_0^a \left( r^3 h - \frac{1}{2} r h^4 \right) dr = 12 \varphi \Big|_0^{2\pi} \left( h \frac{1}{4} r^4 \Big|_0^a - \frac{1}{2} h^4 \cdot \frac{1}{2} r^2 \Big|_0^a \right) =$$

$$= 24\pi \cdot \frac{1}{4} h (a^4 - h^3 a^2) = 6\pi h a^2 (a^2 - h^3) \text{ traženo rješenje}$$

# Površinski integral po zatvorenoj površini pretvoriti uz pomoć formule Ostrogradskoy u trostruki integral po zapremini tijela, koje je ograničeno spojem površina

$$\iint_S \sqrt{x^2+y^2+z^2} [\cos(\vec{n}, x) + \cos(\vec{n}, y) + \cos(\vec{n}, z)] dS$$

gdje je  $\vec{n}$  vanjska normala na površinu  $S$ .

Rj.  $\cos(\vec{n}, x)$  je kosinus ugla između normale i x-ose.  
 $\cos(\vec{n}, y)$  i  $\cos(\vec{n}, z)$  je kosinus ugla između normale na površinu  $S$  i y-ose i z-ose redom.

Uvedimo oznake  $\cos(\vec{n}, x) = \cos \alpha$ ,  $\cos(\vec{n}, y) = \cos \beta$  i  $\cos(\vec{n}, z) = \cos \gamma$ .

Prenos formuli Stokesa znamo da je

$$\begin{aligned} dy dz &= dS \cos \alpha \\ dz dx &= dS \cos \beta \\ dx dy &= dS \cos \gamma \end{aligned}$$

$$\begin{aligned} I &= \iint_S \sqrt{x^2+y^2+z^2} (\cos(\vec{n}, x) + \cos(\vec{n}, y) + \cos(\vec{n}, z)) dS = \\ &= \iint_S \sqrt{x^2+y^2+z^2} (dy dz + dz dx + dx dy) \end{aligned}$$

$$\iint_S P dy dz + Q dz dx + R dx dy = \iiint_{\Omega} \left( \frac{\partial P}{\partial x} + \frac{\partial Q}{\partial y} + \frac{\partial R}{\partial z} \right) dx dy dz$$

$$\frac{\partial P}{\partial x} = \frac{2x}{2\sqrt{x^2+y^2+z^2}}$$

$$I = \iiint_{\Omega} \frac{x+y+z}{\sqrt{x^2+y^2+z^2}} dx dy dz$$

# Izračunati  $\iint_S x^3 dy dz + y^3 dz dx + z^3 dx dy$  gdje je  $S$  - vanjski dio sfere  $x^2 + y^2 + z^2 = R^2$ .

Rj:

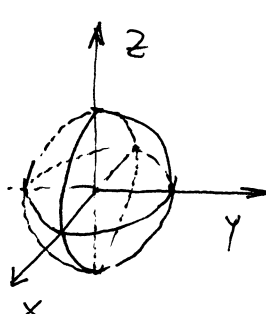

$$I = \iint_S x^3 dy dz + y^3 dz dx + z^3 dx dy \quad \text{Formula Gauss-Ostrogradski}$$

$$= \iiint_{\Omega} \left( \frac{\partial P}{\partial x} + \frac{\partial Q}{\partial y} + \frac{\partial R}{\partial z} \right) dx dy dz$$

$$P = x^3, \quad \frac{\partial P}{\partial x} = 3x^2, \quad Q = y^3, \quad \frac{\partial Q}{\partial y} = 3y^2, \quad R = z^3, \quad \frac{\partial R}{\partial z} = 3z^2$$

$$I = \iiint_{\Omega} (3x^2 + 3y^2 + 3z^2) dx dy dz \quad \Omega: x^2 + y^2 + z^2 \leq R^2$$

Uvedimo sferne koordinate:

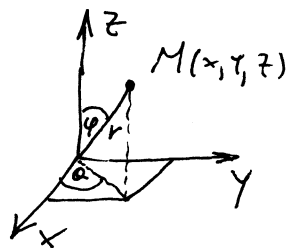

$$\begin{aligned} x &= r \sin \varphi \cos \alpha \\ y &= r \sin \varphi \sin \alpha \\ z &= r \cos \varphi \end{aligned}$$

$$\Omega' = \begin{cases} 0 \leq r \leq R \\ 0 \leq \alpha \leq 2\pi \\ 0 \leq \varphi \leq \pi \\ dx dy dz = r^2 \sin \varphi d\varphi d\alpha dr \end{cases}$$

$$I = 3 \iiint_{\Omega'} r^2 r^2 \sin \varphi d\varphi d\alpha dr = 3 \int_0^R r^4 dr \int_0^{2\pi} d\alpha \int_0^{\pi} \sin \varphi d\varphi =$$

$$= 3 \cdot \frac{1}{5} r^5 \Big|_0^R \cdot \alpha \Big|_0^{2\pi} \cdot (-\cos \varphi) \Big|_0^{\pi} = \frac{3}{5} \cdot R^5 \cdot 2\pi \cdot 2 = \frac{12}{5} R^5 \pi$$



(#) Izračunati  $\iint_S x^2 dy dz + y^2 dx dz + z^2 dx dy$  gdje je  
 S - vanjska strana kocke  $0 \leq x \leq a, 0 \leq y \leq a, 0 \leq z \leq a$ .

Rj.  $\iint_S P dy dz + Q dx dz + R dx dy = \iiint_{\Omega} \left( \frac{\partial P}{\partial x} + \frac{\partial Q}{\partial y} + \frac{\partial R}{\partial z} \right) dx dy dz$   
Formula Gauss-ov.

$$\frac{\partial P}{\partial x} = 2x, \quad \frac{\partial Q}{\partial y} = 2y, \quad \frac{\partial R}{\partial z} = 2z$$

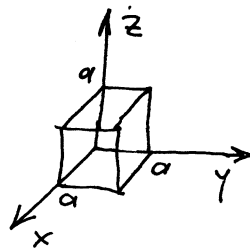

$$\Omega : \begin{cases} 0 \leq x \leq a \\ 0 \leq y \leq a \\ 0 \leq z \leq a \end{cases}$$

Prenaj tome:

$$\iint_S x^2 dy dz + y^2 dx dz + z^2 dx dy =$$

$$= \iiint_{\Omega} (2x + 2y + 2z) dx dy dz = 2 \int_0^a dx \int_0^a dy \int_0^a (x + y + z) dz =$$

$$= 2 \int_0^a dx \int_0^a \left( xz \Big|_0^a + yz \Big|_0^a + \frac{1}{2} z^2 \Big|_0^a \right) dy = 2 \int_0^a dx \int_0^a \left( ax + ay + \frac{1}{2} a^2 \right) dy =$$

$$2a \int_0^a \left( xy \Big|_0^a + \frac{1}{2} y^2 \Big|_0^a + \frac{1}{2} ay \Big|_0^a \right) dx = 2a \int_0^a \left( ax + \frac{1}{2} a^2 + \frac{1}{2} a^2 \right) dx = 2a^2 \int_0^a (x + a) dx =$$

$$= 2a^2 \left( \frac{1}{2} a^2 + a^2 \right) = 3a^4$$

# Zadaci za vježbu

3896. Površinski integral  $\iint_S x^2 dy dz + y^2 dx dz + z^2 dx dy$ , uzet po zatvo-

renoj površini  $S$ , primenom formule Ostrogradskog, transformisati u trojni integral po zapremini ograničenoj tom površinom (Integral se računa po spoljnoj strani površine  $S$ ).

3897. Površinski integral  $\iint_S x^2 + y^2 + z^2 (\cos(N, x) + \cos(N, y) + \cos(N, z)) d\sigma$

po zatvorenoj površini  $S$ , primenom formule Ostrogradskog transformisati u trojni integral po zapremini ograničenoj tom površinom, pri čemu je  $N$  spoljna normala površine  $S$ .

3898. Izračunati integral u prethodnom zadatku ako je  $S$  sfera poluprečnika  $R$  sa centrom u koordinatnom početku.

3899. Izračunati integral

$$\iint_S [x^3 \cos(N, x) + y^3 \cos(N, y) + z^3 \cos(N, z)] d\sigma,$$

u kojem je  $S$  — sfera poluprečnika  $R$  sa centrom u koordinatnom početku, a  $N$  — spoljna normala.

3900. Izračunati integral u zadacima 3891—3893 primenom formule Ostrogradskog.

## Rješenja

$$3896. 2 \iiint_{\Omega} (x+y+z) dx dy dz.$$

$$3897. \iiint_{\Omega} \frac{x+y+z}{\sqrt{x^2+y^2+z^2}} dx dy dz. \quad 3898. 0. \quad 3899. \frac{12}{5} \pi R^5.$$